

# The RF MOSFET Line

## RF Power Field-Effect Transistor

### N-Channel Enhancement-Mode

... designed for wideband large-signal output and driver stages up to 400 MHz range.

- Guaranteed 28 Volt, 150 MHz Performance  
Output Power = 30 Watts  
Minimum Gain = 13 dB  
Efficiency — 60% (Typical)
- Small-Signal and Large-Signal Characterization
- Typical Performance at 400 MHz, 28 Vdc, 30 W  
Output = 7.7 dB Gain
- 100% Tested For Load Mismatch At All Phase Angles  
With 30:1 VSWR
- Low Noise Figure — 1.5 dB (Typ) at 1.0 A, 150 MHz
- Excellent Thermal Stability, Ideally Suited For Class A Operation
- Facilitates Manual Gain Control, ALC and Modulation Techniques

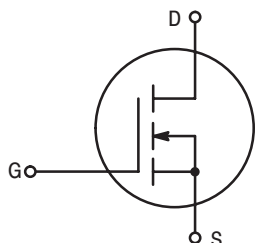
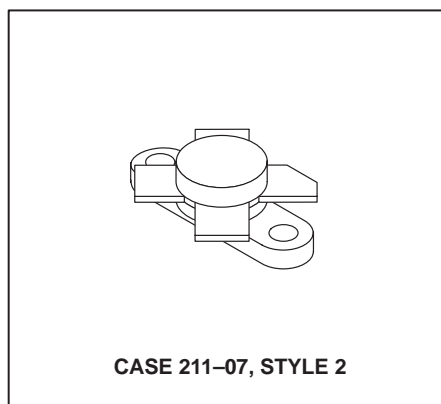
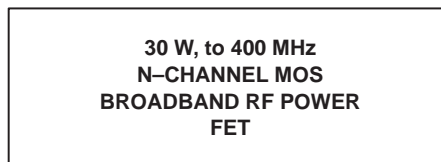

#### MAXIMUM RATINGS

Rating	Symbol	Value	Unit
Drain-Source Voltage	$V_{DSS}$	65	Vdc
Drain-Gate Voltage ( $R_{GS} = 1.0\text{ M}\Omega$ )	$V_{DGR}$	65	Vdc
Gate-Source Voltage	$V_{GS}$	$\pm 40$	Vdc
Drain Current — Continuous	$I_D$	5.0	Adc
Total Device Dissipation @ $T_C = 25^\circ\text{C}$ Derate above $25^\circ\text{C}$	$P_D$	100 0.571	Watts W/ $^\circ\text{C}$
Storage Temperature Range	$T_{stg}$	-65 to +150	$^\circ\text{C}$
Operating Junction Temperature	$T_J$	200	$^\circ\text{C}$

#### THERMAL CHARACTERISTICS

Characteristic	Symbol	Max	Unit
Thermal Resistance, Junction to Case	$R_{\theta JC}$	1.75	$^\circ\text{C/W}$

**Handling and Packaging** — MOS devices are susceptible to damage from electrostatic charge. Reasonable precautions in handling and packaging MOS devices should be observed.

**ELECTRICAL CHARACTERISTICS** ( $T_C = 25^\circ\text{C}$  unless otherwise noted.)

Characteristic	Symbol	Min	Typ	Max	Unit
<b>OFF CHARACTERISTICS</b>					
Drain–Source Breakdown Voltage ( $V_{GS} = 0, I_D = 10 \text{ mA}$ )	$V_{(BR)DSS}$	65	—	—	Vdc
Zero Gate Voltage Drain Current ( $V_{DS} = 28 \text{ V}, V_{GS} = 0$ )	$I_{DSS}$	—	—	4.0	mAdc
Gate–Source Leakage Current ( $V_{GS} = 20 \text{ V}, V_{DS} = 0$ )	$I_{GSS}$	—	—	1.0	$\mu\text{Adc}$

**ON CHARACTERISTICS**

Gate Threshold Voltage ( $V_{DS} = 10 \text{ V}, I_D = 25 \text{ mA}$ )	$V_{GS(th)}$	1.0	3.0	6.0	Vdc
Forward Transconductance ( $V_{DS} = 10 \text{ V}, I_D = 500 \text{ mA}$ )	$g_{fs}$	500	750	—	mmhos

**DYNAMIC CHARACTERISTICS**

Input Capacitance ( $V_{DS} = 28 \text{ V}, V_{GS} = 0, f = 1.0 \text{ MHz}$ )	$C_{iss}$	—	48	—	pF
Output Capacitance ( $V_{DS} = 28 \text{ V}, V_{GS} = 0, f = 1.0 \text{ MHz}$ )	$C_{oss}$	—	54	—	pF
Reverse Transfer Capacitance ( $V_{DS} = 28 \text{ V}, V_{GS} = 0, f = 1.0 \text{ MHz}$ )	$C_{rss}$	—	11	—	pF

**FUNCTIONAL CHARACTERISTICS**

Noise Figure ( $V_{DS} = 28 \text{ Vdc}, I_D = 1.0 \text{ A}, f = 150 \text{ MHz}$ )	NF	—	1.5	—	dB
Common Source Power Gain ( $V_{DD} = 28 \text{ Vdc}, P_{out} = 30 \text{ W}, I_{DQ} = 25 \text{ mA}$ ) $f = 150 \text{ MHz}$ (Figure 1) $f = 400 \text{ MHz}$ (Figure 14)	$G_{ps}$	13 —	16 7.7	— —	dB
Drain Efficiency (Figure 1) ( $V_{DD} = 28 \text{ Vdc}, P_{out} = 30 \text{ W}, f = 150 \text{ MHz}, I_{DQ} = 25 \text{ mA}$ )	$\eta$	50	60	—	%
Electrical Ruggedness (Figure 1) ( $V_{DD} = 28 \text{ Vdc}, P_{out} = 30 \text{ W}, f = 150 \text{ MHz}, I_{DQ} = 25 \text{ mA},$ VSWR 30:1 at All Phase Angles)	$\psi$	No Degradation in Output Power			

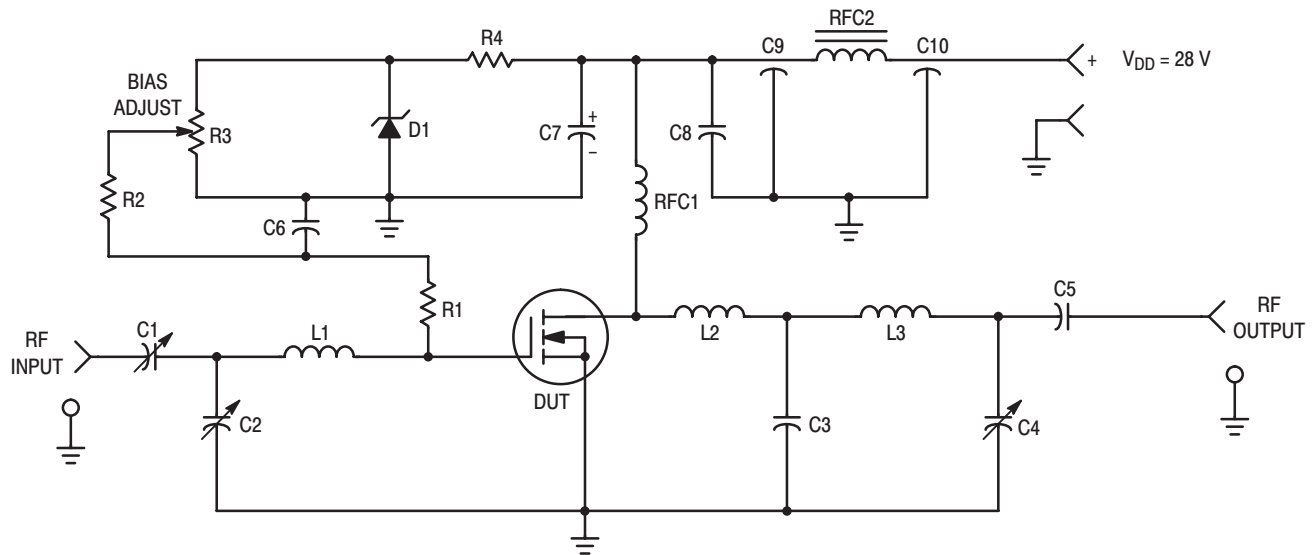

- C1 — Arco 403, 3.0–35 pF, or equivalent
- C2 — Arco 406, 15–115 pF, or equivalent
- C3 — 56 pF Mini–Unelco, or equivalent
- C4 — Arco 404, 8.0–60 pF, or equivalent
- C5 — 680 pF, 100 Mils Chip
- C6 — 0.01  $\mu\text{F}$ , 100 V, Disc Ceramic
- C7 — 100  $\mu\text{F}$ , 40 V
- C8 — 0.1  $\mu\text{F}$ , 50 V, Disc Ceramic
- C9, C10 — 680 pF Feedthru
- D1 — 1N5925A Motorola Zener

- L1 — 2 Turns, 0.29" ID, #18 AWG Enamel, Closewound
- L2 — 1–1/4 Turns, 0.2" ID, #18 AWG Enamel, Closewound
- L3 — 2 Turns, 0.2" ID, #18 AWG Enamel, Closewound
- RFC1 — 20 Turns, 0.30" ID, #20 AWG Enamel, Closewound
- RFC2 — Ferroxcube VK–200 — 19/4B
- R1 — 10 k $\Omega$ , 1/2 W Thin Film
- R2 — 10 k $\Omega$ , 1/4 W
- R3 — 10 Turns, 10 k $\Omega$
- R4 — 1.8 k $\Omega$ , 1/2 W
- Board — G10, 62 Mils

Figure 1. 150 MHz Test Circuit

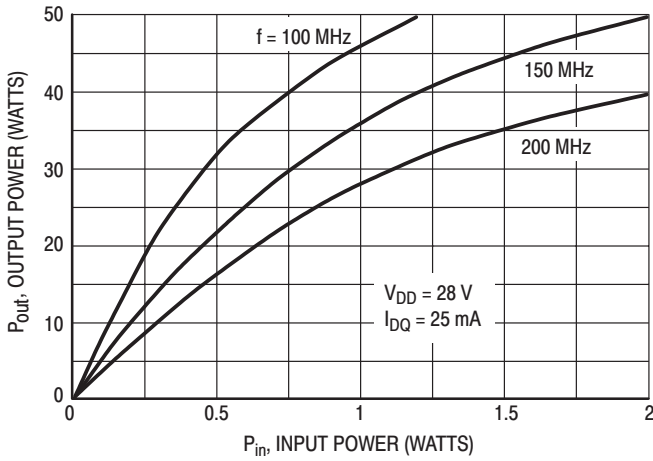

Figure 2. Output Power versus Input Power

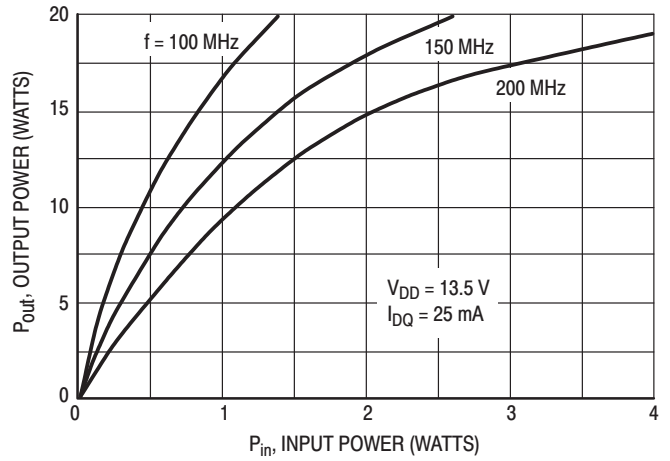

Figure 3. Output Power versus Input Power

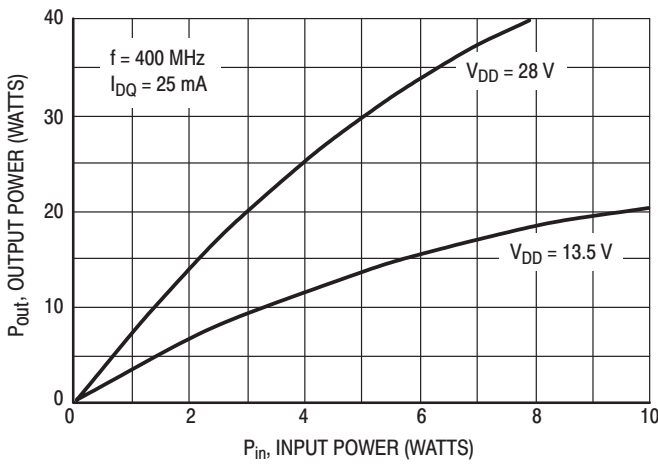

Figure 4. Output Power versus Input Power

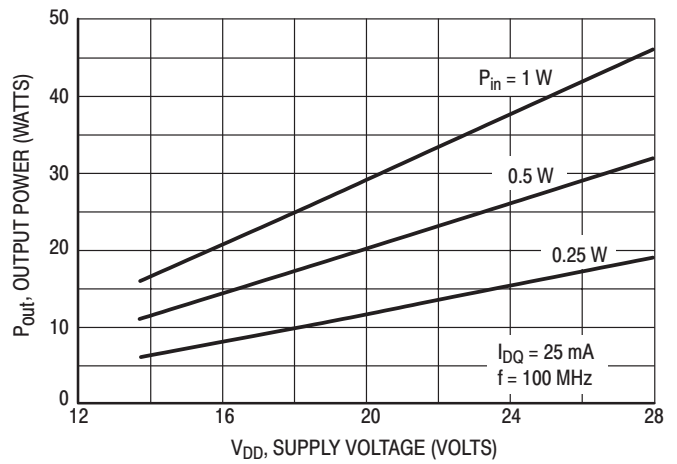

Figure 5. Output Power versus Supply Voltage

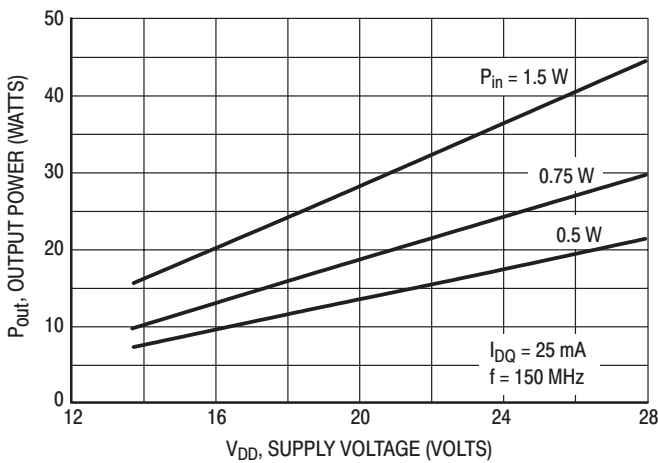

Figure 6. Output Power versus Supply Voltage

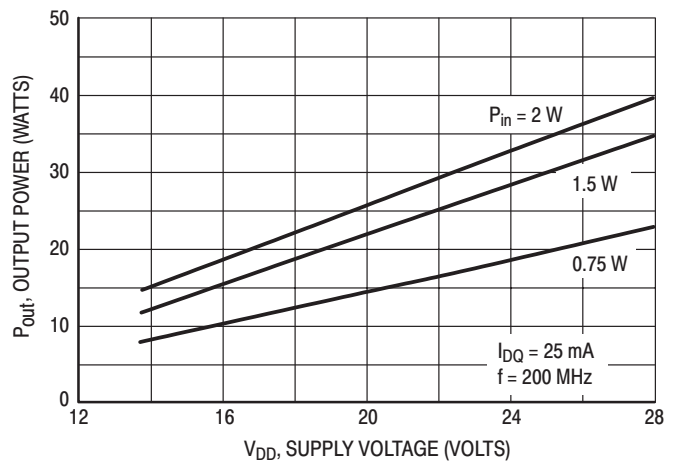

Figure 7. Output Power versus Supply Voltage

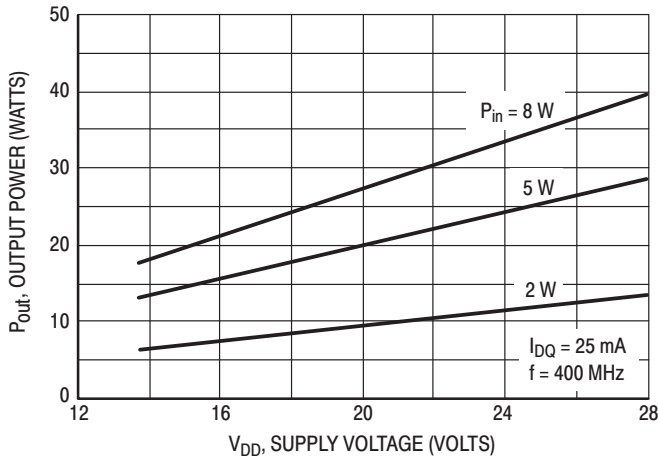

Figure 8. Output Power versus Supply Voltage

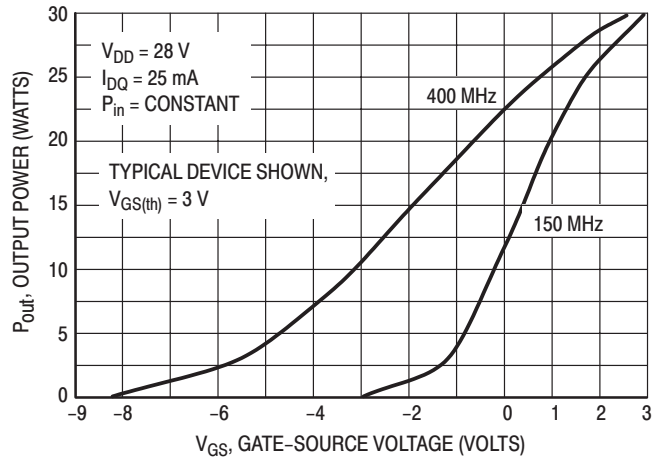

Figure 9. Output Power versus Gate Voltage

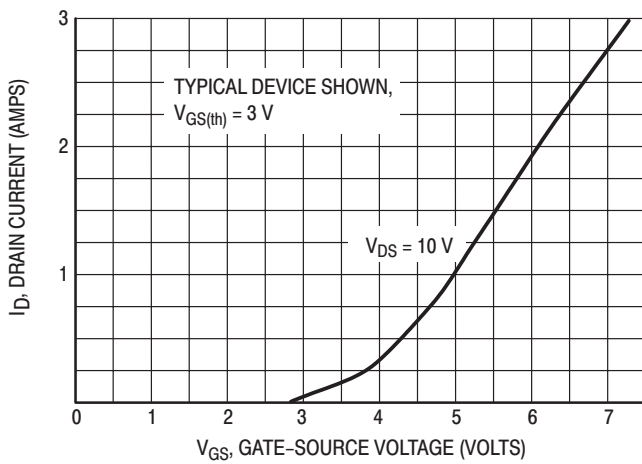

Figure 10. Drain Current versus Gate Voltage (Transfer Characteristics)

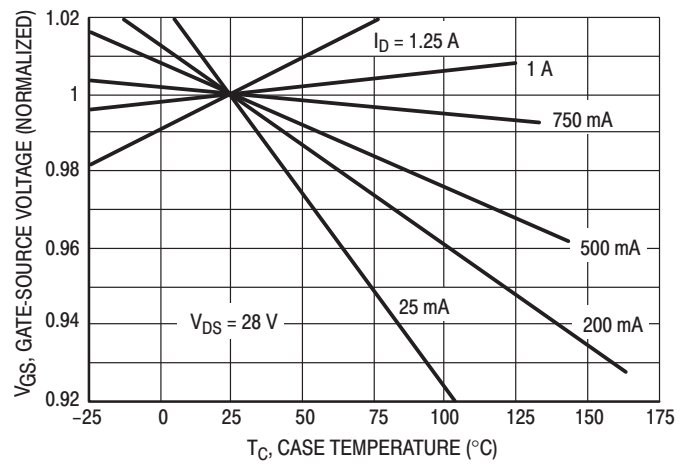

Figure 11. Gate Source Voltage versus Case Temperature

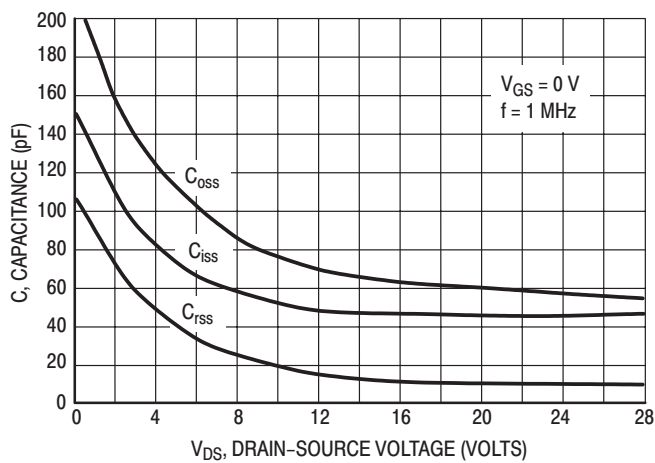

Figure 12. Capacitance versus Drain-Source Voltage

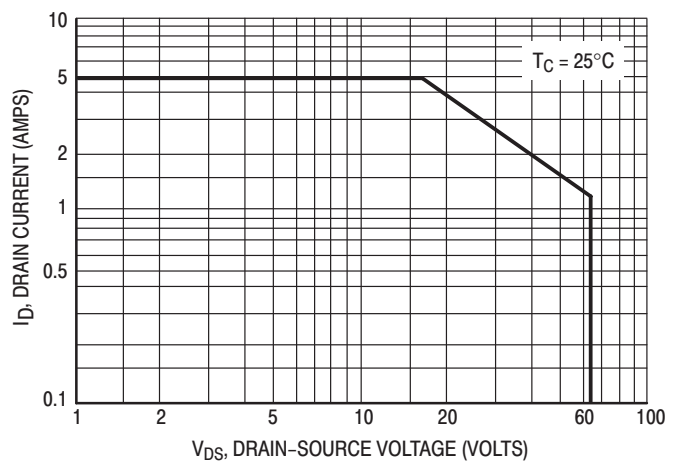
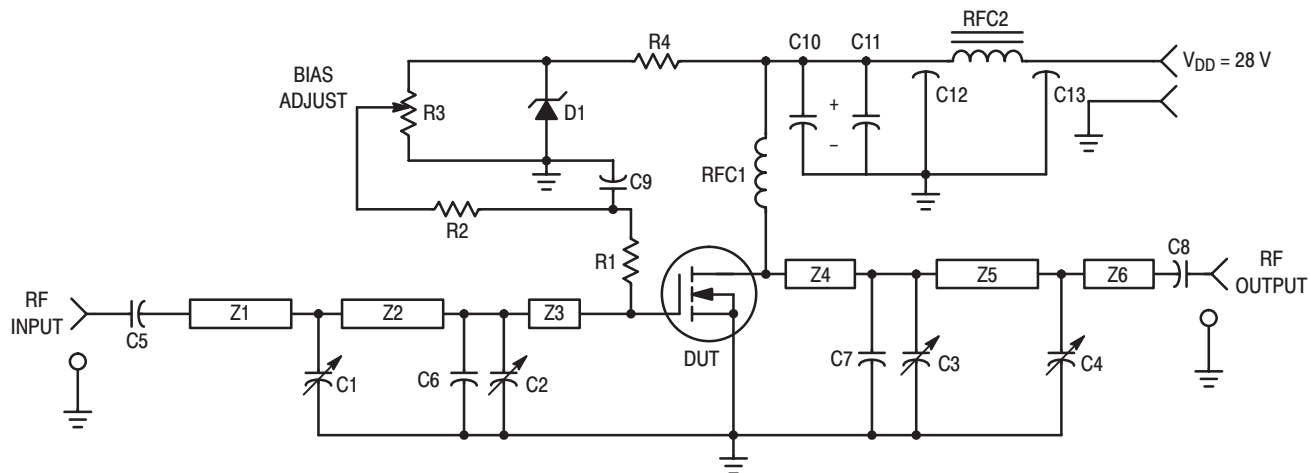

Figure 13. DC Safe Operating Area



- |  |   |
|--|---|
| C1, C2, C3, C4 — 0–20 pF Johanson, or equivalent | R4 — 1.8 k $\Omega$ , 1/2 W                           |
| C5, C8 — 270 pF, 100 Mil Chip                    | Z1 — 2.9" x 0.166" Microstrip                         |
| C6, C7 — 24 pF Mini–Unelco, or equivalent        | Z2, Z4 — 0.35" x 0.166" Microstrip                    |
| C9 — 0.01 $\mu$ F, 100 V, Disc Ceramic           | Z3 — 0.40" x 0.166" Microstrip                        |
| C10 — 100 $\mu$ F, 40 V                          | Z5 — 1.05" x 0.166" Microstrip                        |
| C11 — 0.1 $\mu$ F, 50 V, Disc Ceramic            | Z6 — 1.9" x 0.166" Microstrip                         |
| C12, C13 — 680 pF Feedthru                       | RFC1 — 6 Turns, 0.300" ID, #20 AWG Enamel, Closewound |
| D1 — 1N5925A Motorola Zener                      | RFC2 — Ferroxcube VK–200 — 19/4B                      |
| R1, R2 — 10 k $\Omega$ , 1/4 W                   | Board — Glass Teflon, 62 Mils                         |
| R3 — 10 Turns, 10 k $\Omega$                     |   |

Figure 14. 400 MHz Test Circuit

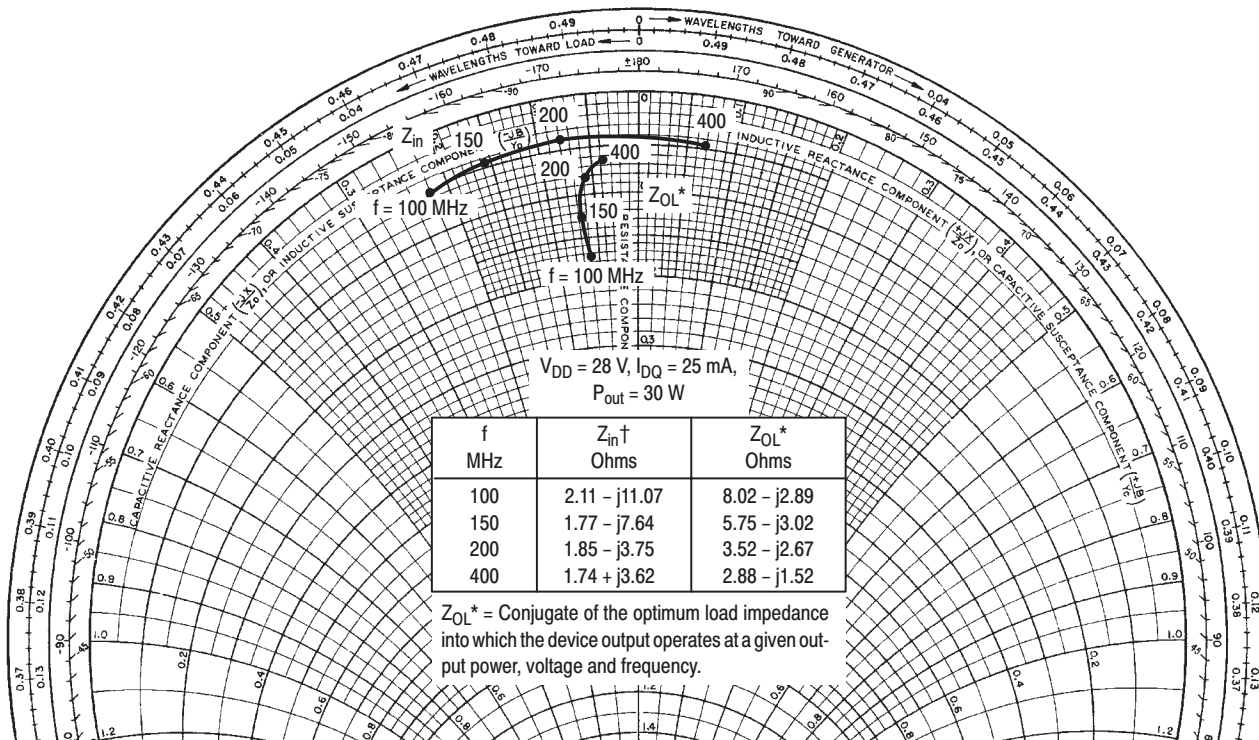
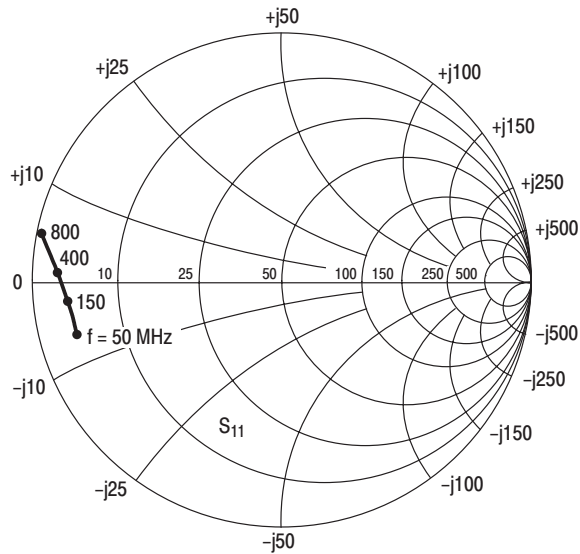

Figure 15. Large-Signal Series Equivalent Input and Output Impedance, Z<sub>in</sub>, Z<sub>OL</sub>\*

f (MHz)	S <sub>11</sub>		S <sub>21</sub>		S <sub>12</sub>		S <sub>22</sub>	
	S <sub>11</sub>	∠φ	S <sub>21</sub>	∠φ	S <sub>12</sub>	∠φ	S <sub>22</sub>	∠φ
2.0	0.977	-32	59.48	163	0.011	67	0.661	-36
5.0	0.919	-70	48.67	142	0.024	44	0.692	-78
10	0.852	-109	33.50	122	0.032	29	0.747	-117
20	0.817	-140	19.05	106	0.037	16	0.768	-146
30	0.814	-153	13.11	99	0.038	14	0.774	-157
40	0.811	-159	9.88	95	0.038	13	0.782	-162
50	0.812	-164	7.98	92	0.038	12	0.787	-165
60	0.813	-166	6.66	89	0.038	12	0.787	-168
70	0.815	-168	5.708	86	0.038	11	0.787	-169
80	0.816	-170	5.003	84	0.038	11	0.787	-170
90	0.817	-171	4.560	83	0.038	12	0.787	-171
100	0.817	-172	4.170	81	0.039	13	0.787	-172
110	0.818	-173	3.670	80	0.039	13	0.788	-172
120	0.820	-173	3.420	79	0.039	13	0.788	-173
130	0.821	-173	3.170	79	0.039	13	0.788	-173
140	0.822	-174	2.980	78	0.039	13	0.788	-173
150	0.823	-175	2.826	77	0.039	14	0.788	-173
160	0.824	-175	2.650	76	0.039	14	0.790	-174
170	0.825	-176	2.438	75	0.039	14	0.792	-174
180	0.827	-176	2.325	73	0.039	15	0.793	-174
190	0.829	-177	2.175	72	0.039	16	0.796	-174
200	0.831	-177	2.084	71	0.039	16	0.799	-174
225	0.836	-178	1.824	69	0.039	18	0.805	-174
250	0.846	-178	1.621	66	0.039	21	0.816	-174
275	0.853	-179	1.462	64	0.039	23	0.822	-174
300	0.853	-179	1.319	61	0.040	25	0.833	-174
325	0.856	-179	1.194	59	0.040	27	0.828	-174
350	0.857	+179	1.089	56	0.040	30	0.842	-174
375	0.861	+179	1.014	54	0.042	32	0.849	-174
400	0.865	+178	0.927	51	0.043	35	0.856	-174
425	0.875	+178	0.876	49	0.045	37	0.866	-174
450	0.881	+178	0.810	46	0.046	40	0.870	-174
475	0.886	+177	0.755	44	0.046	43	0.875	-174
500	0.887	+177	0.694	41	0.051	43	0.888	-174
525	0.888	+176	0.677	39	0.052	43	0.890	-174
550	0.896	+176	0.625	36	0.055	45	0.898	-174
575	0.907	+175	0.603	34	0.058	45	0.913	-174
600	0.910	+175	0.585	32	0.061	45	0.918	-174
625	0.910	+174	0.563	30	0.065	45	0.945	-174
650	0.920	+174	0.543	28	0.069	46	0.952	-174
675	0.938	+173	0.533	26	0.074	47	0.974	-174
700	0.943	+171	0.515	24	0.078	47	0.958	-176
725	0.934	+170	0.491	22	0.079	46	0.953	-177
750	0.940	+170	0.475	22	0.084	48	0.943	-177
775	0.953	+169	0.477	21	0.090	48	0.957	-177
800	0.959	+168	0.467	17	0.093	48	0.957	-179

Table 1. Common Source Scattering Parameters  
50 Ω System  
V<sub>DS</sub> = 28 V, I<sub>D</sub> = 0.75 A



**Figure 16.  $S_{11}$ , Input Reflection Coefficient versus Frequency**  
 $V_{DS} = 28\text{ V}$   $I_D = 0.75\text{ A}$

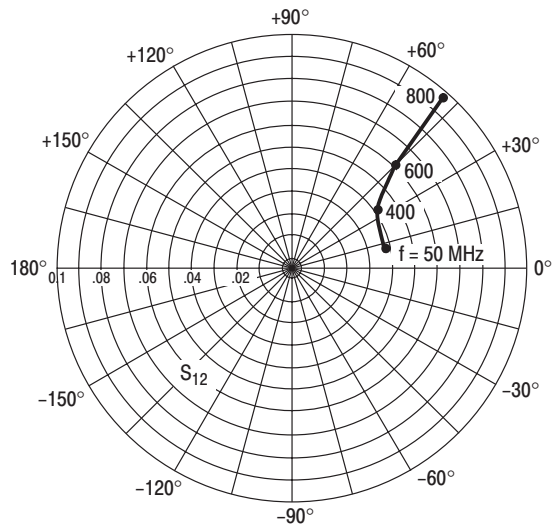

**Figure 17.  $S_{12}$ , Reverse Transmission Coefficient versus Frequency**  
 $V_{DS} = 28\text{ V}$   $I_D = 0.75\text{ A}$

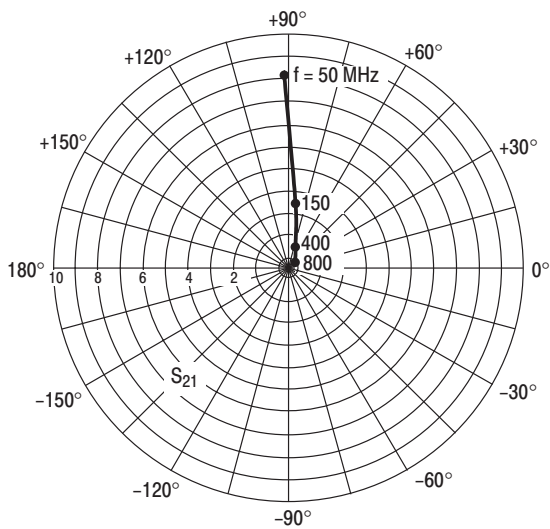

**Figure 18.  $S_{21}$ , Forward Transmission Coefficient versus Frequency**  
 $V_{DS} = 28\text{ V}$   $I_D = 0.75\text{ A}$

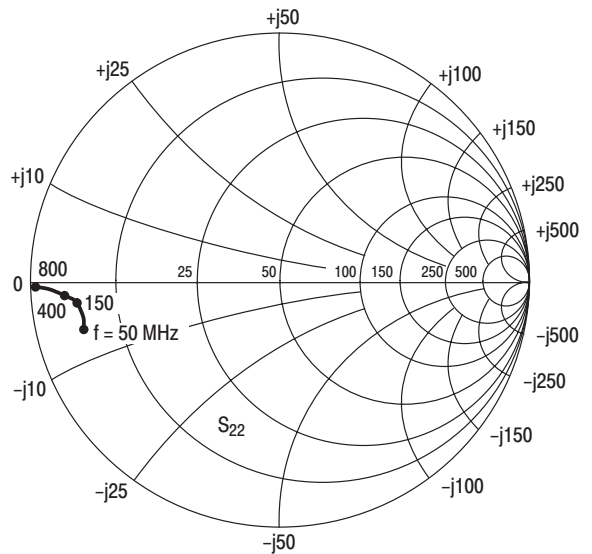

**Figure 19.  $S_{22}$ , Output Reflection Coefficient versus Frequency**  
 $V_{DS} = 28\text{ V}$   $I_D = 0.75\text{ A}$

## DESIGN CONSIDERATIONS

The MRF137 is a RF power N-Channel enhancement mode field-effect transistor (FET) designed especially for VHF power amplifier applications. M/A-COM RF MOS FETs feature a vertical structure with a planar design, thus avoiding the processing difficulties associated with V-groove vertical power FETs.

M/A-COM Application Note AN211A, FETs in Theory and Practice, is suggested reading for those not familiar with the construction and characteristics of FETs.

The major advantages of RF power FETs include high gain, low noise, simple bias systems, relative immunity from thermal runaway, and the ability to withstand severely mismatched loads without suffering damage. Power output can be varied over a wide range with a low power dc control signal, thus facilitating manual gain control, ALC and modulation.

## DC BIAS

The MRF137 is an enhancement mode FET and, therefore, does not conduct when drain voltage is applied. Drain current flows when a positive voltage is applied to the gate. See Figure 10 for a typical plot of drain current versus gate voltage. RF power FETs require forward bias for optimum performance. The value of quiescent drain current ( $I_{DQ}$ ) is not critical for many applications. The MRF137 was characterized at  $I_{DQ} = 25$  mA, which is the suggested minimum value of  $I_{DQ}$ . For special applications such as linear amplification,  $I_{DQ}$  may have to be selected to optimize the critical parameters.

The gate is a dc open circuit and draws no current. Therefore, the gate bias circuit may generally be just a simple

resistive divider network. Some special applications may require a more elaborate bias system.

## GAIN CONTROL

Power output of the MRF137 may be controlled from its rated value down to zero (negative gain) by varying the dc gate voltage. This feature facilitates the design of manual gain control, AGC/ALC and modulation systems. (See Figure 9.)

## AMPLIFIER DESIGN

Impedance matching networks similar to those used with bipolar VHF transistors are suitable for MRF137. See M/A-COM Application Note AN721, Impedance Matching Networks Applied to RF Power Transistors. The higher input impedance of RF MOS FETs helps ease the task of broadband network design. Both small signal scattering parameters and large signal impedances are provided. While the s-parameters will not produce an exact design solution for high power operation, they do yield a good first approximation. This is an additional advantage of RF MOS power FETs.

RF power FETs are triode devices and, therefore, not unilateral. This, coupled with the very high gain of the MRF137, yields a device capable of self oscillation. Stability may be achieved by techniques such as drain loading, input shunt resistive loading, or output to input feedback. Two port parameter stability analysis with the MRF137 s-parameters provides a useful tool for selection of loading or feedback circuitry to assure stable operation. See M/A-COM Application Note AN215A for a discussion of two port network theory and stability.



## PACKAGE DIMENSIONS

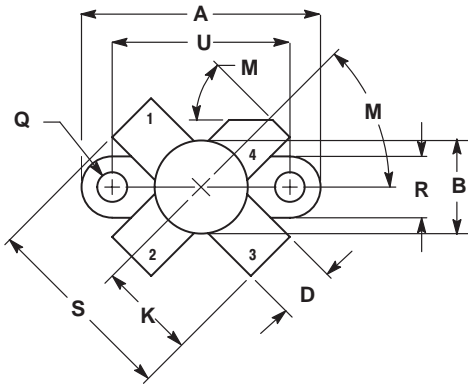

- NOTES:  
 1. DIMENSIONING AND TOLERANCING PER ANSI Y14.5M, 1982.  
 2. CONTROLLING DIMENSION: INCH.

DIM	INCHES		MILLIMETERS	
	MIN	MAX	MIN	MAX
A	0.960	0.990	24.39	25.14
B	0.370	0.390	9.40	9.90
C	0.229	0.281	5.82	7.13
D	0.215	0.235	5.47	5.96
E	0.085	0.105	2.16	2.66
H	0.150	0.108	3.81	4.57
J	0.004	0.006	0.11	0.15
K	0.395	0.405	10.04	10.28
M	40°	50°	40°	50°
Q	0.113	0.130	2.88	3.30
R	0.245	0.255	6.23	6.47
S	0.790	0.810	20.07	20.57
U	0.720	0.730	18.29	18.54

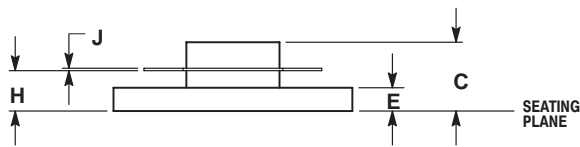

- STYLE 2:  
 PIN 1. SOURCE  
 2. GATE  
 3. SOURCE  
 4. DRAIN

**CASE 211-07  
 ISSUE N**

*Specifications subject to change without notice.*

- **North America:** Tel. (800) 366-2266, Fax (800) 618-8883
- **Asia/Pacific:** Tel.+81-44-844-8296, Fax +81-44-844-8298
- **Europe:** Tel. +44 (1344) 869 595, Fax+44 (1344) 300 020

Visit [www.macom.com](http://www.macom.com) for additional data sheets and product information.

REV 6

**tyco** / Electronics

**MACOM**